



Ficha Técnica Digital



Electric Option

Esquema de Contactos

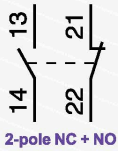

2-pole NC + NO

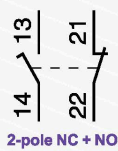

2-pole NC + NO

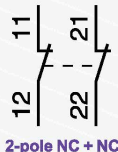

2-pole NC + NC

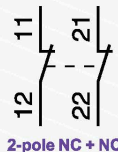

2-pole NC + NC

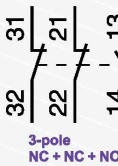

3-pole
NC + NC + NO

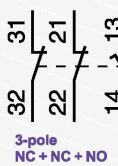

3-pole
NC + NC + NO

Forma de Contacto

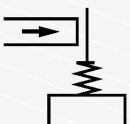
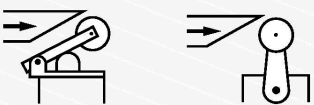
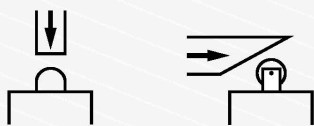

Parámetros Técnicos	
Voltaje Nominal	240VAC
Corriente a 250VAC	3A
Contactos	DPST 1NO + 1NC
Voltaje Máximo de Impulso	6kV
Grado de Protección	IP65
Material del Cuerpo	Metal

Dimensiones

XCK-M102

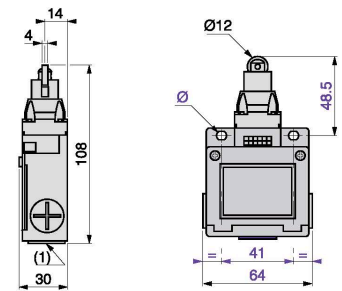

XCK-M110

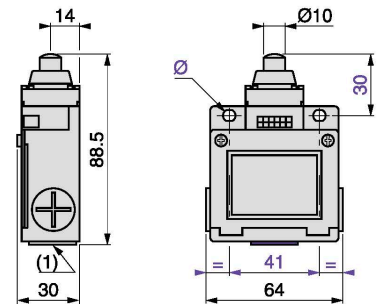

XCK-M115

