



7-day room temperature controller REV34..

Heating applications

- Mains-independent, battery-operated room temperature controller featuring user-friendly operation, easy-to-read display and large numbers.
- 3-position controller with PI mode and optimum start control.
- Possibility to adapt volume and control gain.
- Operating mode selection:
 - 7-day automatic mode with max. 3 heating phases.
 - Continuous comfort mode.
 - Continuous energy saving mode.
 - Frost protection.
 - Exception day (24 hour operation) with max. 3 heating phases.
- A separate temperature setpoint can be entered in automatic mode and for the exception day for each heating phase.
- Heating zone control.

Use

Room temperature control in:

- Single-family and vacation homes.
- Apartments and offices.
- Individual rooms and professional office facilities.
- Commercially used spaces.

To control electric 3-position actuators with a running time of **120...150 seconds**, for use with stroke and rotary actuators.

Function

- PI control.
- 3-point control.
- 7-day time switch.
- Remote control.
- Preselected 24-hour operating modes.
- Override button.
- Holiday mode.
- Party mode.
- Frost protection.
- Holiday mode.
- Information level to check settings.
- Reset function.
- Sensor calibration.
- Optimum start control in the morning (P.1).
- Adaption of integral action time (volume adaption).
- Adaption of control gain (heat output adaption).
- Synchronization to radio time signal from Frankfurt, Germany (REV34DC).

Type summary

Room temperature controller with 7-day time switch

REV34

Room temperature controller with 7-day time switch and receiver for time signal from Frankfurt, Germany (DCF77)

REV34DC

Ordering

Please indicate the type number as per the "Type summary" when ordering.

Delivery

The controller is supplied with batteries.

Mechanical design









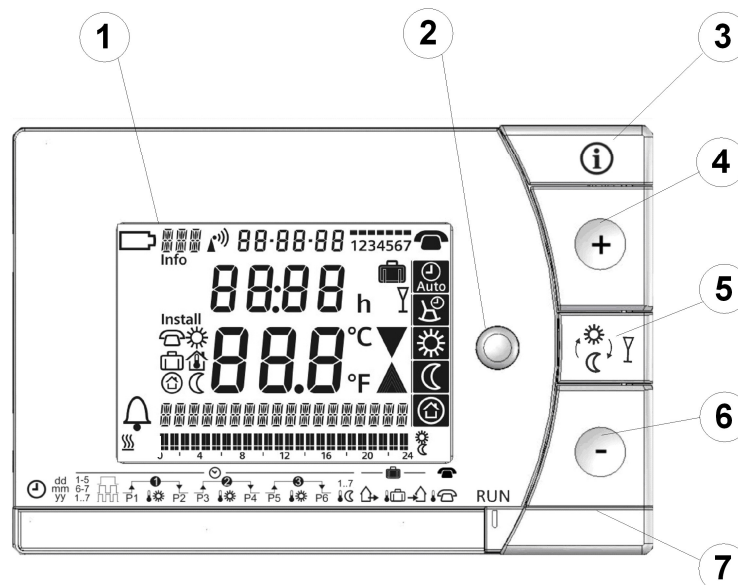









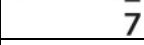

Plastic casing with an easy-to-read display and large numbers, easily accessible operating elements, and removable base.





The housing contains the controller's electronics, DIP switches, and the relay with potential-free changeover contact. The easily accessible battery compartment allows for easy exchange of two 1.5 V alkaline batteries, type AA.

The base with terminal block provides lots of space to connect the wires.

Display and operating elements







1 Display				
	Change battery	21.0°C	Room temperature (measured)	
	Alarm	TEMPERATURE	Clear text display line (max. 18 spaces)	
	Heating mode		24 hour timeframe	
	Weekday (max. 3 spaces)		Switching pattern with flashing time cursor	
Info	Info		Weekday block	
Without language selection		Setpoint for remote control		
				
		Setpoint for absence	h	Time unit
		Room temperature		Absence/holiday mode set
		Setpoint for frost protection mode		Absence/holiday mode active
		Energy saving mode setpoint		Party mode active
		Time signal from Frankfurt	°C / °F	Temperature unit °C or °F
17-03-08	Date (day - month - year)		Close actuator/valve	
22:30	Time of day		Open actuator/valve	
			Remote control active	











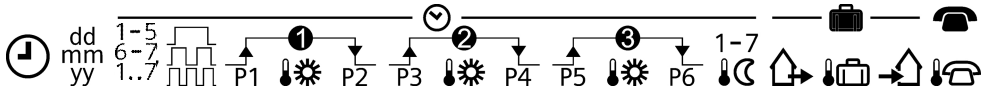





2 Operating mode selector	
	Automatic weekly mode with max. three heating phases per day.
	Exception day with max. three heating phases.
	Continuous comfort mode (= continuous comfort temperature).
	Continuous energy saving mode (= continuous energy saving temperature).
	Frost protection.

3 INFO	
	Pressing the Info button once illuminates the display. Illumination automatically turns off after a short period of time. Pressing the Info button again activates the information display: Info is lit. The unit first displays queued error messages followed by important information (e.g. time switch programs, etc.).

4 Plus button	
	Increase values, set time, or make a selection.



5	Override button / party mode
	<p>In the time switch program, this button allows you to quickly change from the active temperature level to the next and back.</p> <p>Thus, you can quickly change to energy saving temperature when you leave the apartment for a short period of time, thus saving energy.</p> <p>The display indicates the change. It is valid only until the next switching time.</p> <p>Activate party mode: Press the button for 3 seconds.</p> <p>Party mode is available only in operating modes  and . In party mode, the controller controls to a freely selectable temperature for a freely selectable period of time.</p> <p>In party mode, symbol Y is displayed along with the end of party mode.</p>

6	Minus button
	Decrease values, set time, or make a selection

7	Program selection slider
	
	Time.
dd mm yy	Day – Month – Year (2 spaces for day, month, and year)
1-5 6-7 1..7	Weekday, weekend, or individual day blocks
	1, 2, or 3 heating phases
 P1	Start Heating phase 1
 1	Setpoint Heating phase 1
 P2	End Heating phase 1
 P3	Start Heating phase 2
 2	Setpoint Heating phase 2
 P4	End Heating phase 2
 P5	Start Heating phase 3
 3	Setpoint Heating phase 3
 P6	End Heating phase 3
1-7 	Energy saving temperature in the automatic mode and exception day time switch programs
	Start of absence / holiday
	Temperature setpoint during absence / holiday
	End of absence / holiday
	Temperature setpoint at active remote control
RUN	Slider position RUN allows for closing the cover

Operating modes

Operation with time switch program



The controller offers the two time switch programs  and .

Enter a start time and end time for each heating phase. Also comfort temperature setpoint can be freely entered for each heating phases. Between the heating phases the controller always switches to the same, freely selectable energy saving temperature setpoint.

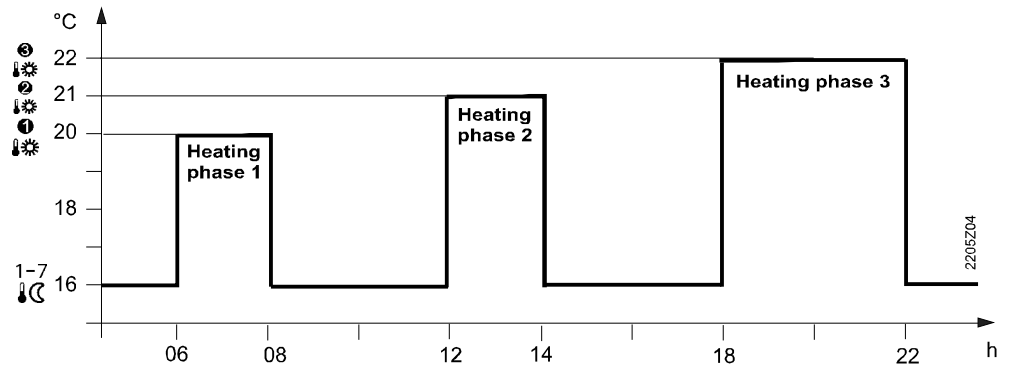
Example with 3 heating phases



Continuous operating modes

The controller also offers the three continuous modes  comfort mode,  energy saving mode and  frost protection mode.





Setpoints



You can freely adjust the setpoints for the weekly and 24-hour operating modes.

Setting range for all setpoints without setpoint limitation 3...35 °C.

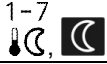
Setting range for all setpoints with setpoint limitation 16...35 °C.

Factory setting

Factory settings: Heating		
		20 °C
		16 °C
		8 °C
		12 °C

Factory settings: Switching times						
Heating phases	P1	P2	P3	P4	P5	P6
1. 	07:00	23:00	PASS	PASS	PASS	PASS
2. 	06:00	08:00	17:00	22:00	PASS	PASS
3. 	06:00	08:00	11:00	13:00	17:00	22:00

7-day time switch

Three different switching patterns are available to simplify entry of switching times. These can be assigned as blocks to the corresponding weekdays 1...5 and weekend days 6...7. As a result, you need to adapt the switching times and room temperatures only once for each block.

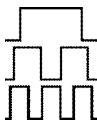
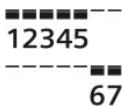
Switching pattern	Blocks
	















You can also enter individual days 1 ... 1 .

Enter holidays or absences

You can enter the beginning, temperature and end of your holidays. At the beginning of the holidays, the controller switches to the desired holiday temperature and returns to the previously set operating mode at the end of the holidays.

In holiday mode, symbol  is displayed along with the end of holiday mode.

Proceed as follows to enter your settings:

	Set slider to position 15 (start of absence): Press  or  to set the start date for your holidays.
	Set slider to position 16 (temperature during absence): Press  or  to set the desired temperature while on holidays.
	Set slider to position 17 (end of absence): Press  or  to set the end date for your holidays.
RUN	Return the slider to position RUN . Symbol  is displayed to the left of the  symbol. Press  ,  ,  ,  or move the slider to end holiday mode prematurely.

Remote control

Use a suitable remote control unit to activate the "Remote control"  temperature setpoint in the controller. Changeover takes place by making a **potential-free contact** connected to terminals T1 and T2.

A flashing  symbol indicates active remote control mode.

After the contact opens, the previously set operating mode is reactivated.

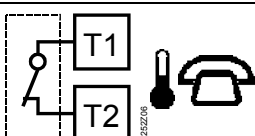
Operation according to controller setting	Temperature setpoint "remote control" active
	

Suitable remote control units are:



Telephone modem, manual switch, window contact, presence detector, central unit, etc.

Enter temperature for active remote control

You can freely select the temperature for active remote control. Activating remote control immediately enables control to the remote control temperature regardless of the currently active operating mode. When you deactivate remote control, the controller returns to the set operating mode.



A flashing  symbol indicates active remote control mode.

Proceed as follows to enter your settings:

	Set slider to temperature position for active remote control: Press  or  to set the desired temperature for active remote control.
RUN	Return the slider to position RUN .

Technical features

DIP switches



△ ON / ▽ OFF		1	2	3	4	5	6	7	8	9	10	See	
See A	Sensor calibration On	△					△	△				Medium-sized room	E
	Sensor calibration Off	▽					△	▽				Small room	
B	Setpoint limitation 16...35 °C		△				▽	△				Large room	
	Setpoint limitation 3...35 °C		▽				▽	▽				Medium-sized room	
C	Temperature display °F			△					△	△		Normally sized heat output	F
	Temperature display °C			▽					△	▽		Undersized heat output	
D	Start optimization: 1 h/°C				△	△			▽	△		Oversized heat output	
	Start optimization: ¼ h/°C				△	▽			▽	▽		Normally sized heat output	
	Start optimization: ½ h/°C				▽	△					△	Quartz	
	Start optimization: Off				▽	▽					▽	 Radio clock	G
H	 <p>DIP switch reset</p> <p>After you change one or several DIP switch positions, you must press the DIP switch reset button to reset the DIP switch (see also Fig. 5). Otherwise, the previous setting remains active!</p>											H	
Factory setting: All DIP switches to ▽ OFF													

A Sensor calibration: DIP switch 1

If the displayed room temperature does not match the measured room temperature, the temperature sensor can be recalibrated.

Set DIP switch to ON and press the DIP switch reset button:

CAL symbol is displayed. The currently measured temperature flashes.

Press  or  to recalibrate by max. ± 5 °C.

Set DIP switch to OFF and press the DIP switch reset button to save the settings.

B Setpoint limitation: DIP switch 2

The minimum setpoint limitation of 16 °C prevents undesired heat transfer to neighboring spaces in buildings featuring several heating zones.

DIP switch ON: Setpoint limitation **16...35 °C**.

DIP switch OFF: Setpoint limitation **3...35 °C** (factory setting).

Press the DIP switch reset button to save the settings.

C Temperature display in °C or °F: DIP switch 3

DIP switch ON: Temperature display in **°F**.

DIP switch OFF: Temperature display in **°C** (factory setting).

Press the DIP switch reset button to save the settings.

D Start optimization: DIP switches 4 and 5

Optimization advances the switch-on point P.1 to ensure that the selected setpoint is reached at the desired time. The setting depends on the controlled system, i.e., on heat transmission (piping system, radiators), building dynamics (building mass, insulation), and heat output (boiler capacity, flow temperature).

DIP switches 4 ON and 5 ON: 1 h/°C For slow controlled systems.

DIP switches 4 ON and 5 OFF: ¼ h/°C For fast controlled systems.

DIP switches 4 OFF and 5 ON: ½ h/°C For medium controlled systems.

DIP switches 4 OFF and 5 OFF: OFF Off, no effect (factory setting).

Press the DIP switch reset button to save the settings.

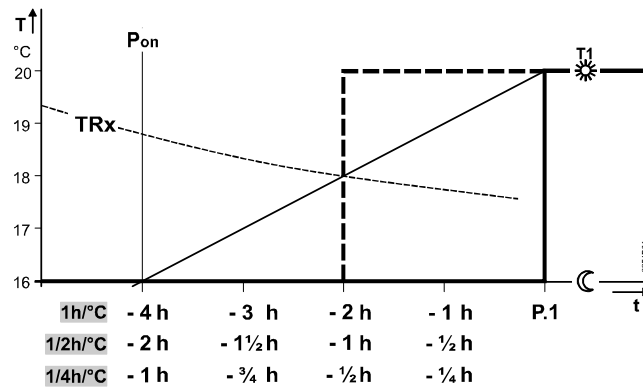

Key for diagram:

- T Temperature (°C)
- t Forward shift of switch-on point (h)
- TRx Room temperature actual value
- Pon Starting point for optimized heat-up time.

E Integral action time
(Volume adaption):
DIP switches 6 and 7

- DIP switches 6 ON and 7 ON:
Normally sized controlled system, see factory setting.
- DIP switches 6 ON and 7 OFF:
Fast controlled system: For small rooms, light radiators (plate heat exchangers), well insulated building or fan coils.
- DIP switches 6 OFF and 7 ON:
Slow controlled system: For large rooms, heavy radiators (cast iron radiators), poorly insulated building, and large masses.
- DIP switches 6 OFF and 7 OFF (factory setting):
Normally sized controlled system: For normal-size rooms, normally sized radiators (steel pipe radiator) and average insulated building.

Press the DIP switch reset button to save the settings.

F Control gain
(Heat output adaptation):
DIP switches 8 and 9

- DIP switches 8 ON and 9 ON:
Normally sized heat output, see factory setting.
- DIP switches 8 ON and 9 OFF:
Undersized heat output:
For low boiler/flow temperatures, undersized radiators (area) and undersized volumetric flow (valve nominal width).
- DIP switches 8 OFF and 9 ON:
Oversized heat output:
For high boiler/flow temperatures, oversized radiators (area) and oversized volumetric flow (valve nominal width).
- DIP switch 8 OFF and 9 OFF (factory setting):
Normally sized heat output.

Press the DIP switch reset button to save the settings.

G Radio clock:
DIP switch 10

- Only applicable to REV..DC (with integrated DCF77 receiver to receive time signal from Frankfurt, Germany)!
 - DIP switch ON: Clock run by controller-internal quartz.
 - DIP switch OFF: Time signal DCF77 from Frankfurt, Germany.
- Press the DIP switch reset button to save the settings.

Note
on synchronization

During startup, REV..DC synchronizes automatically to the time signal (DCF77) from Frankfurt, Germany. Synchronization takes max. 10 minutes. Synchronization restarts each time you press the button or move the program selection slider from the RUN position during these 10 minutes. Siemens recommends to set the desired settings

upon startup, install the REV..DC in the desired location, and not carry out any actions on the REV..DC for the next 10 minutes.

In normal operation, the REV..DC synchronizes to the radio clock every day at 3:10 a.m.

Note
on reception

The time signal from Frankfurt is modulated to a radio signal. The reception of this radio signal depends on the distance to Frankfurt, atmospheric conditions as well as the location where the REV..DC is installed. Siemens cannot guarantee that the REV..DC can receive the time signal from Frankfurt at any time and any place.

No reception

The radio clock symbol is deactivated and an error message is displayed if the clock was not able to synchronize the time for 7 consecutive days. The controller then runs on the internal quartz.

H DIP switch reset

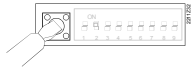

After you change one or several DIP switch positions, you must press the DIP switch reset button to reset the DIP switch.

Otherwise, the previous setting remains active!

Access to the expert level

Set the program selection slider to RUN. Press **+** and **-** simultaneously for 3 seconds, release the buttons, and within 3 seconds press and hold down **0** and **Ⓜ** simultaneously for 3 seconds, release **Ⓜ**, and press **0** for another 3 seconds. This releases the engineering settings. **Install** is displayed.

The display first shows language selection with Code 00. Press the buttons **+** or **-** to navigate the settings.

Confirm settings by pressing **Ⓜ**.

Press the operating mode selector **0** to exit the engineering settings.

Code list

Function block	Code	Name	Factory setting	Your setting
Basic settings	00	Language	English	
	01	Sensor calibration	off	
	02	Switching differential 2-point	0.5 °C	
LCD optimization	10	Illumination time	10 seconds	
	11	Background brightness	0	
	12	Contrast	0	
Clock settings	30	Time zone Deviation from time signal in Frankfurt (Central European Time CET) (see Note 1)	0 hours	
	31	Start of daylight saving time (see Note 2)	March 31 (03-31)	
	32	End of daylight saving time (see Note 3)	October 31 (10-31)	

Note 1: This entry has no effect if the radio clock either is inactive or not available.

The time signal received from Frankfurt is shifted by the value set in Code 30 (time zone) if the radio clock is active.





Note 2:

The time is always changed over at 2 a.m. on the Sunday preceding the set date if there is no radio clock or if it is inactive. The time change is shifted by the value set in Code 30 (time zone) when the radio clock is active.

Note 3:

The time is always changed over at 3 a.m. on the Sunday preceding the set date if there is no radio clock or if it is inactive.

Functional check

- a) Check the display. If there is no display, check insertion and function of the batteries.
- b) Operating mode "Continuous comfort mode" , read displayed temperature.
- c) Set temperature setpoint to maximum (see operating instructions).
- d) After 1...5 minutes, the relay to open the actuator must switch on. Symbol  is displayed. The actuator OPENS. If not:
 - Check actuating device and wiring.
 - It is possible that the room temperature is higher than the set temperature setpoint.
- e) Set temperature setpoint to minimum (see operating instructions).
- f) After 1...5 minutes, the relay to open the actuator must switch off and the relay to close the actuator must switch on. Symbol  is displayed. The actuator CLOSES. If not:
 - Check actuating device and wiring.
 - It is possible that the room temperature is lower than the set temperature setpoint.
- g) Set the temperature setpoint for operating mode "Continuous comfort mode"  to the desired value.
- h) Select the desired operating mode.

Reset

User-defined settings:



,  and  simultaneously for 3 seconds:

This resets all temperature and time settings of the program selection slider to default values (see also "Factory settings" in the operating instructions). The expert settings remain unchanged.

The clock starts at 12 p.m., the date on 01-01-08 (01 January 2008).

During the reset, all display fields are lit and can be checked accordingly.

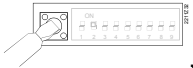
All user-defined settings plus expert settings:

Press the DIP switch reset button ,  and  simultaneously for 5 seconds:

After the reset, **all factor settings** are reloaded. This applies to the program selection slider as well as to the expert settings.



The controller starts with an initialization phase of 180 seconds after each reset. In this phase, the actuator is driven to the basic position CLOSED.

Important: Driving the actuator to the fully CLOSED position takes max. 150 seconds. After a reset, reinsert the controller in the base within **30 seconds**.

- Mount the room unit in the main living room.
- Select the mounting place so that the sensor can acquire the air temperature in the room as accurately as possible and without being influenced by solar radiation or other heat or refrigeration sources.
- Mounting height is approx. 1.5 m above the floor.
- You can mount the unit on most commercially available recessed conduit boxes or directly on the wall.

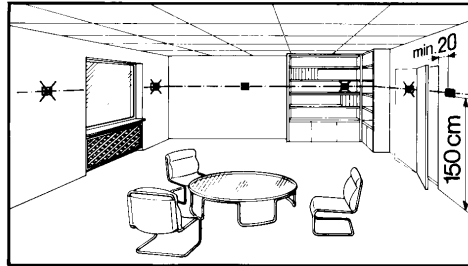

Mounting and installation

- Begin installation by first attaching and wiring the base. You can mount the base on most commercially available recessed conduit boxes or directly on the wall. Insert the controller from top to bottom in the base. See the operating instructions delivered with the unit for more information.
- Comply with all local regulations on electrical installations.
- Wire the remote control contact T1/ T2 separately, i.e. using a separate, screened cable.



Warning!

No internal line protection for supply lines to external consumers.

Risk of fire and injury due to short-circuits!

- Adapt the line diameters as per local regulations to the rated value of the installed overcurrent protection device.
- The power supply line must have an external circuit breaker with a rated current of no more than 10 A.
- Set any thermostatic radiator valves to their fully open position, if present in the reference room.
- Recalibrate the temperature sensor (see "Sensor calibration") if the displayed room temperature does not match the room temperature measured.

Preparations to commission the unit

Commissioning

- Remove the battery transit tab.
- The unit is ready for operation and executes a 180 second initialization period as soon as you remove the transit tab from the battery contact. In this phase, the actuator is driven to the basic position CLOSED.

Important:

Driving the actuator to the fully CLOSED position takes max. 150 seconds.

Reinsert the controller in the base within 30 seconds after removing the black battery transit tab!

Select operating language

- During the above actuator initialization phase, the controller type is displayed at the top left along with a welcome message "THANK YOU..." in all available languages.
- Press any button to interrupt the scrolling text. Operating language selection starts with "ENGLISH" (factory setting). Press **+** or **-** until you reach the desired operating language. Press  or move the slider to confirm the selected operating language.
- If synchronization is not yet completed after language selection, the remaining time is counted down on the display.

Do not press any button during this time!

- If synchronization is complete after you select the operating language, you can continue to set the time of day (as needed), date, comfort phases, etc..

Notes

This is a software class A controller designed for use at a normal degree of pollution.

Disposal



The device is considered electrical and electronic equipment for disposal in terms of the applicable European Directive and may not be disposed of as domestic garbage.

- Dispose of the device through channels provided for this purpose.
- Comply with all local and currently applicable laws and regulations.
- Dispose of empty batteries in designated collection points.



⚠ WARNING

Risk of explosion due to fire or short-circuit, even if the batteries are empty

Risk of injuries from by flying parts

- Do not allow the batteries to come into contact with water.
- Do not charge the batteries.
- Do not damage or destroy the batteries.
- Do not heat the batteries to more than 85 °C.



⚠ WARNING

Electrolyte leakage

Chemical burns

- Only grasp damaged batteries using suitable protective gloves.
- If electrolyte comes into contact with eyes, immediately rinse eyes with plenty of water. Consult a doctor.

Observe the following:

- Only replace batteries with batteries of the same type and from the same manufacturer.
- Observe the polarities (+/-).
- The batteries must be new and free from damage.
- Do not mixed new batteries with used batteries.
- Store, transport, and dispose of the batteries in accordance with local regulations, guidelines, and laws. Also observe information from the battery manufacturer.

Technical data

General unit data	Power	DC 3 V
	Batteries (alkaline AA)	2 x 1.5 V
	Life	Ca. 2 years
	Backup of clock when changing battery (all other data remain in EEPROM)	Max. 1 min
	Switching capacity of relay	
	Voltage	AC 24...250 V
	Current	0.1...6 (2.5) A
	No internal fuse	
	External preliminary protection with max. C 10 A circuit breaker in the supply line required under all circumstances.	
	Protection class	II as per EN 60 730-1
Sensing element	NTC 10 kΩ Ω1 % at 25 °C	
Measuring range	0...50 °C	
Time constant	Max. 10 min	
Setpoint setting ranges		
All temperature settings	3...35 °C	
Resolution for settings and displays		
Setpoints	0.2 °C	
Switching times	10 min	
Actual value measurement	0.1 °C	
Actual value display	0.2 °C	
Time display	1 min	
Standards	EU Conformity (CE)	REV34 and REV34-XA: 8000078256_xx ^{*)} REV34DC: 8000078257_xx ^{*)}
	RCM conformity	A5W00007437 ^{*)}
Product safety	Degree of protection	IP20
Environmental conditions	Operation	
	Climatic conditions	3K3 as per IEC 60 721-3-3
	Temperature	5...40 °C
	Humidity	< 85 % r.h.
	Storage and transport	
	Climatic conditions	2K3 as per IEC 60 721-3-2
	Temperature	-25...70 °C
	Humidity	< 93 % r.h.
	Mechanical conditions	2M2 as per IEC 60 721-3-2
	Weight	Excl. packaging
Color	Housing	RAL9003 signal white
	Base	RAL7038 gray
Size	Housing with base	90 x 134.5 x 30 mm

^{*)} The documents can be downloaded from <http://siemens.com/bt/download>.

Connection diagrams

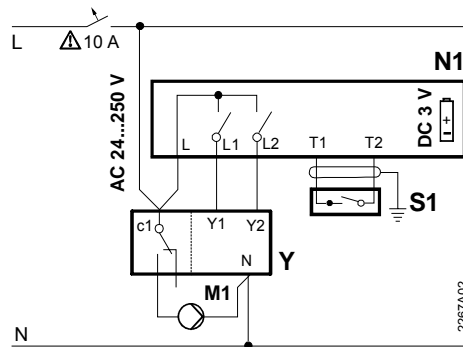
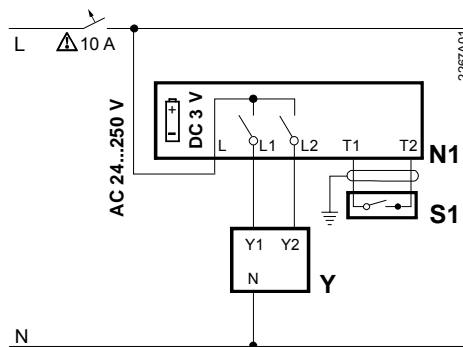

c1 Auxiliary switch
 L Phase, AC 24 ...250 V
 L1 N.O. contact, AC 24 ...250 V / 6 (2.5) A
 L2 N.O. contact, AC 24 ...250 V / 6 (2.5) A
 M1 Circulating pump
 N Neutral conductor
 N1 REV34.. room temperature controller

S1 Remote control unit (potential-free)
 T1 Remote control signal
 T2 Remote control signal
 Y1 Positioning signal "open"
 Y2 Positioning signal "close"
 Y Actuating device

Application examples

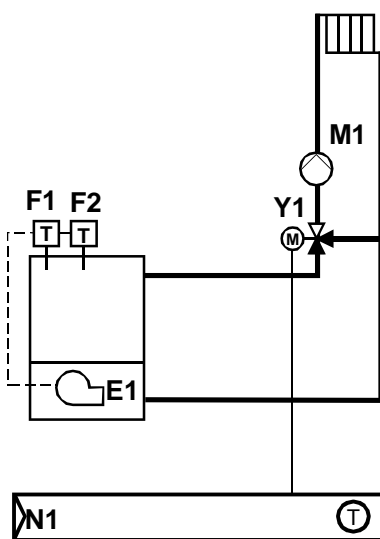

Instantaneous water heater

N1 REV34.. room temperature controller
 Y1 Three-port valve with actuator
 M1 Circulating pump

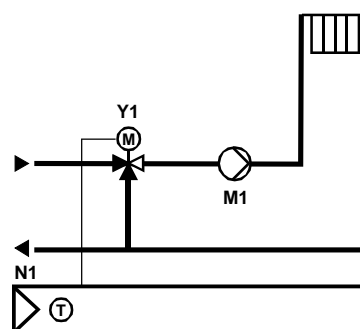

Zone valve

E1 Burner
 F1 Thermal reset limit thermostat
 F2 Manual reset safety limit thermostat

Dimensions

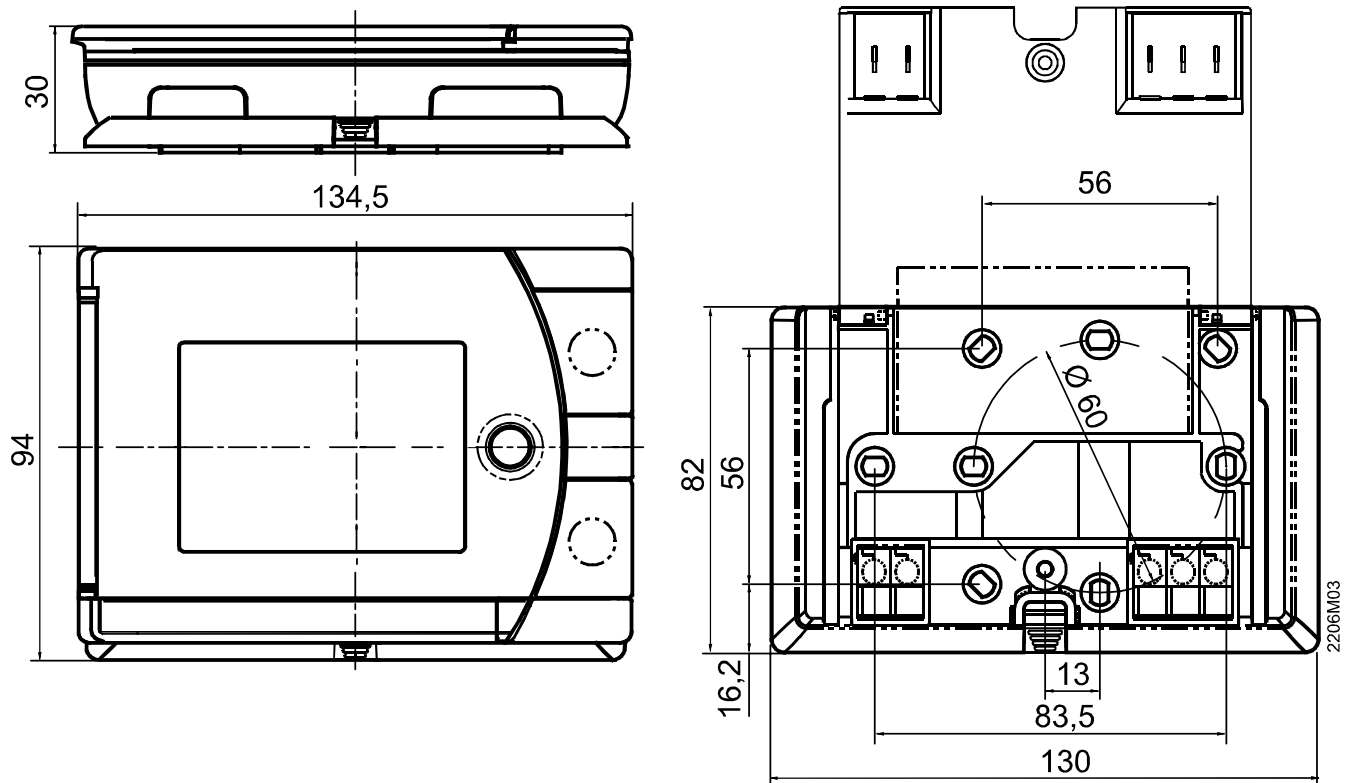

Issued by
Siemens Switzerland Ltd.
Building Technologies Division
International Headquarters
Theilerstrasse 1a
CH-6300 Zug
Tel. +41 58 724 2424
www.siemens.com/buildingtechnologies

16 / 16

© Siemens Switzerland Ltd, 2008 - 2018
Technical specifications and availability subject to change without notice.