



www.esbe.se



SERIES VTD300



NO.1 IN HYDRONIC SYSTEM CONTROL

Mtrl.nr: 9814 04 08 • Ritn.nr: 921B • utg. C • Rev. 1106



Series VTD322

CE
PED 97/23/EC

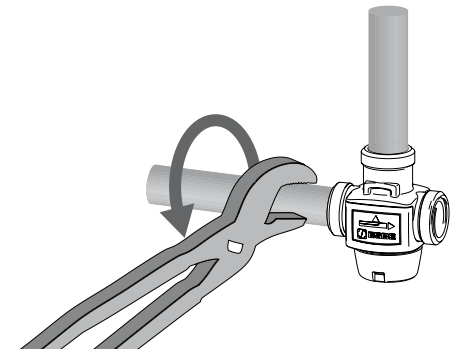
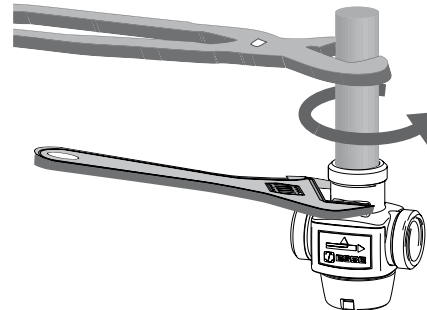
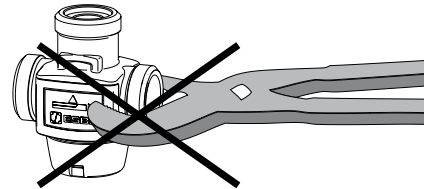
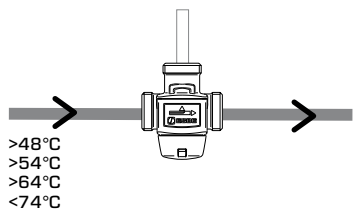
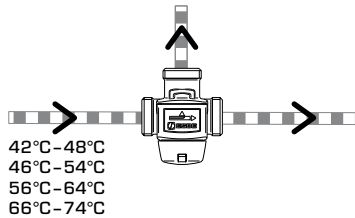
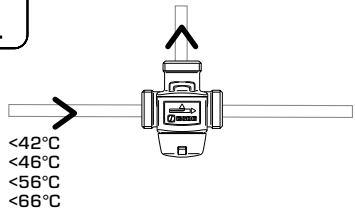
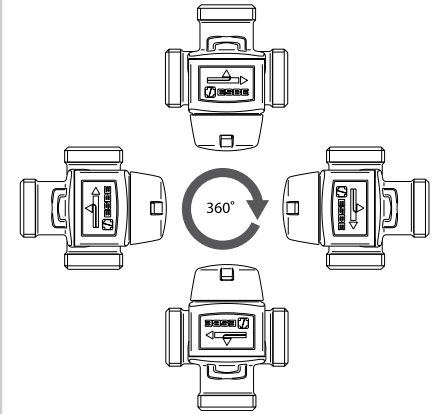
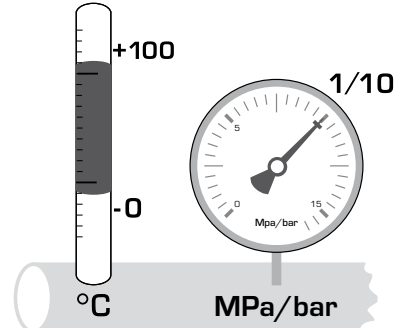

2

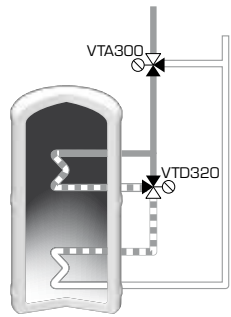

3

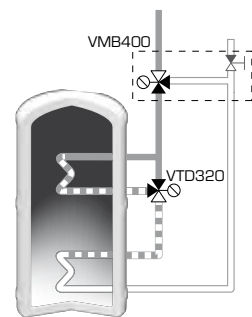

4

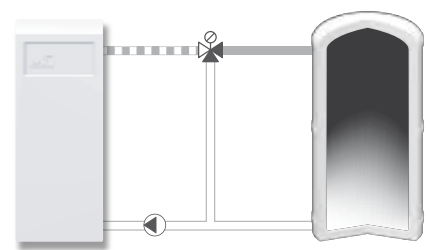

5

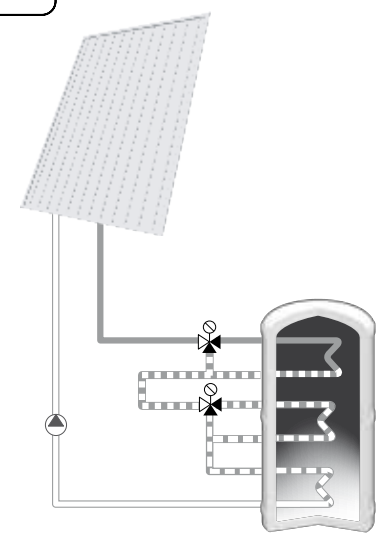

6

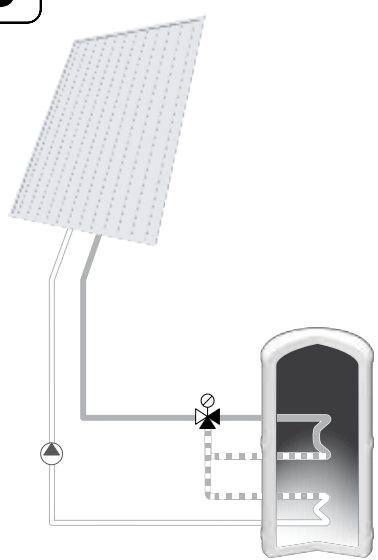

All piping Schematics are General Representations

i

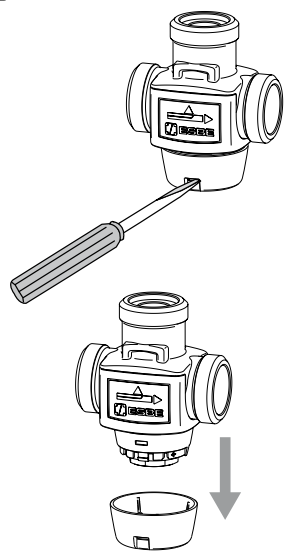

VTD322

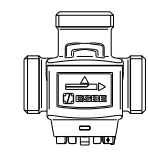

VTD911

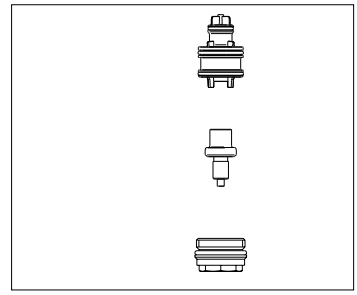

"Denna produkt är anpassad till Branschregler och Säker Vatteninstallation. Leverantören garanterar produktens funktion om branschreglerna och monteringsanvisningen följs."