

MIXING VALVE SERIES VRB140

The compact rotary mixing valve series VRB140 for bivalent heating systems is available in DN 15–50, and is made of brass. Three types of connections are available; internal thread, external thread and compression fittings. PN 10. Patented + Registered design.

OPERATION

ESBE series VRB140 is a range of compact rotary mixing valve developed for bivalent systems, i.e. where two heat sources are connected in series or parallel. With an actuator and a control device, the ESBE VRB140 can be used to prioritize between heat sources.

For easy manual operation the valves are equipped with non-slip knobs and end stops for an operation angle of 90°. The valve position scale can be turned over and rotated, allowing a wide choice of mounting positions. Together with actuator series ESBE ARA600, the VRB140 valves are also easily automated and have extraordinary regulating accuracy thanks to the unique valve-to-actuator interface. For more advanced control functions, the ESBE controllers allows even more applications.

ESBE VRB140 valves are available in dimensions DN 15–50 with internal thread, in DN 15–50 with external thread and with compression fittings for pipe O.D. 22 and 28 mm.

FUNCTION

The BIV valve has two inlets to which the heat sources can be connected either in parallel or in series. The primary, i.e. the low grade heat source should be connected to port 1 and the secondary to port 2. When no heat is needed, both ports 1 and 2 are closed. When heat is needed, the supply from port 1 is used as long as the required temperature can be maintained. When this is no longer the case the valve provides initially a mixed flow from ports 1 and 2. Finally port 2 is fully open and port 1 closed. (The function is like a 3-way valve but with two inlets instead of one.)

The BIV valve may also be used on water storage tanks where two outlets from the tank are required. One outlet at the top of the tank and one half way down the tank serve the valve and the return line from the heating system is connected to the bottom of the tank. With this arrangement the hot water from the top of the tank will be used in conjunction with the cooler water drawn from the mid position.

SERVICE AND MAINTENANCE

The slender and compact design of the valve allows for easy tool access when assembling and disassembling the valve.

Repair kits are available for key components.



Internal thread



External thread



Compression fitting

VALVE VRB140 DESIGNED FOR

- Heating
- Comfort cooling
- Potable water
- Floor heating
- Solar heating
- Ventilation
- Zone
- District hot water
- District heating
- District cooling

SUITABLE ACTUATORS AND CONTROLLERS

- Series ARA600
- Series 90*
- Series 90C
- Series CRC110
- Series CRB100
- Series CRA110

* Adaptor kit necessary, see product page

TECHNICAL DATA

Pressure class: _____ PN 10
 Media temperature: _____ max. (continuously) +110°C
 _____ max. (temporarily) +130°C
 _____ min. -10°C
 Torque (at nominal pressure) DN15-32: _____ < 3 Nm
 DN40-50: _____ < 5 Nm
 Leakrate in % of flow*: _____ < 0.5%
 Working pressure: _____ 1 MPa (10 bar)
 Max. differential pressure drop: _____ Mixing, 100 kPa (1 bar)
 _____ Diverting, 200 kPa (2 bar)
 Close off pressure: _____ 200 kPa
 Rangeability Kv/Kv^{min}, A-AB: _____ 100
 Connections: _____ Internal thread, EN 10226-1
 _____ External thread, ISO 228/1
 _____ Compression fitting, EN 1254-2

* Differential pressure 100kPa (1 bar)

Material

Valve body: _____ Dezincification resistant brass, DZR
 Slide: _____ Abrasion resistant brass
 Shaft and bushing: _____ PPS composite
 O-rings: _____ EPDM

PED 97/23/EC, article 3.3

VALVE CHARACTERISTICS

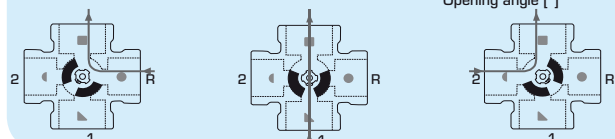
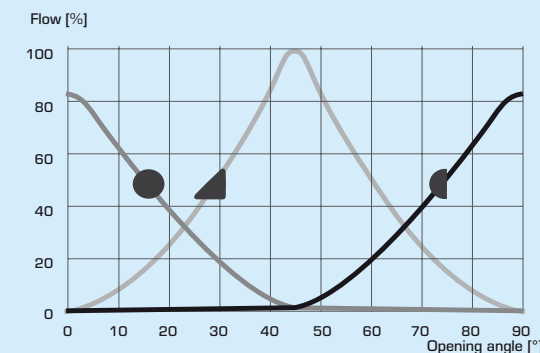

MIXING VALVE SERIES VRB140

INSTALLATION EXAMPLES

All the examples of installation can be mirrored. The valve position scale can be turned over and rotated to fit a number of installation layouts and shall at the installation be fitted in the correct position as shown in the instruction for installation. The symbol markings of the valve ports (■●▲) minimize the risk of incorrect installation.

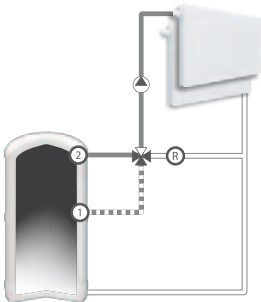

Storage tank mixing

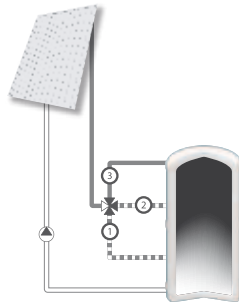

Storage tank loading

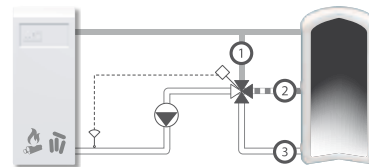

Storage tank loading

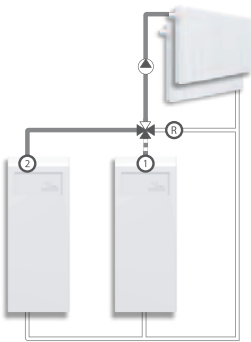

Parallel heat sources

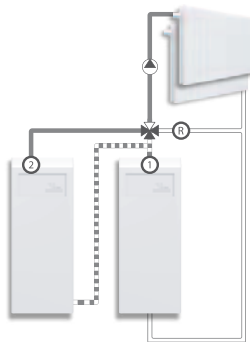

Serial heat sources

We would like to pinpoint to the existence of a German patent DE 19821256C5 affecting the usage of bivalent 4-way valves in liquid circulation heating systems. In this patent the usage of a 4-way bivalent valve in a type of heating system protected, in which 2 different heating circuits are operated in parallel, where the return of the first circuit is utilized as heatsource for the parallel second heat circuit. A typical application would be a primary heat circuit with a heatsource and a parallel floor heating, where the floorheating in a regulated manner is heated through its heatsource and the return from the primary circuit the return of the first heat circuit is utilized as alternative secondary heatsource for the floor heating. Such a utilization of our bivalent 4-way valve is without approval of the patent holder forbidden. All other applications our product group VRB are without restrictions possible.

MIXING VALVE SERIES VRB140

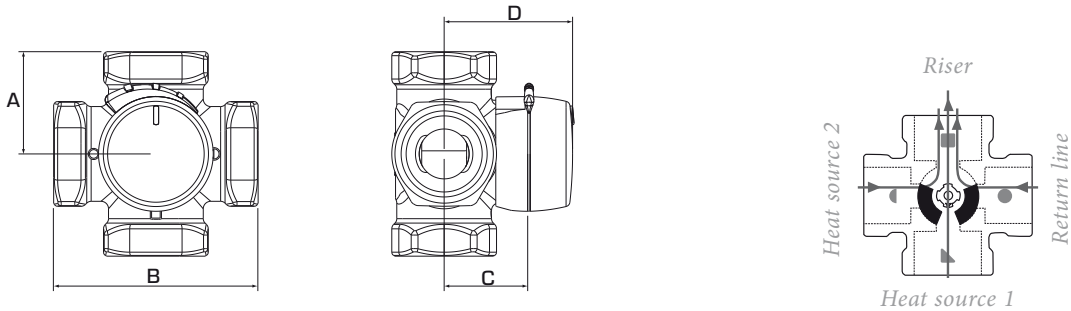

The flat-sided spindle top points towards the sleeve input.

SERIES VRB141, INTERNAL THREAD

Art. No.	Reference	DN	Kvs*	Connection	A	B	C	D	Weight [kg]	Note
1166 01 00	VRB141	15	2.5	Rp 1/2"	36	72	32	50	0.40	
1166 02 00	VRB141	20	4	Rp 3/4"	36	72	32	50	0.52	
1166 03 00			6.3							
1166 04 00	VRB141	25	10	Rp 1"	41	82	34	52	0.80	
1166 05 00	VRB141	32	16	Rp 1 1/4"	47	94	37	55	1.08	
1166 20 00	VRB141	40	25	Rp 1 1/2"	53	106	44	60	1.98	
1166 22 00	VRB141	50	35	Rp 2"	60	120	46	64	2.65	

SERIES VRB142, EXTERNAL THREAD

Art. No.	Reference	DN	Kvs*	Connection	A	B	C	D	Weight [kg]	Note
1166 08 00	VRB142	15	2.5	G 3/4"	36	72	32	50	0.40	
1166 24 00			4							
1166 09 00	VRB142	20	4	G 1"	36	72	32	50	0.52	
1166 10 00			6.3							
1166 11 00	VRB142	25	10	G 1 1/4"	41	82	34	52	0.80	
1166 12 00	VRB142	32	16	G 1 1/2"	47	94	37	55	1.08	
1166 21 00	VRB142	40	25	G 2"	53	106	44	60	1.99	
1166 23 00	VRB142	50	35	G 2 1/4"	60	120	46	64	2.65	

SERIES VRB143, COMPRESSION FITTING

Art. No.	Reference	DN	Kvs*	Connection	A	B	C	D	Weight [kg]	Note
1166 15 00	VRB143	20	4	CPF 22 mm	36	72	32	50	0.40	
1166 16 00			6.3							
1166 17 00	VRB143	25	6.3	CPF 28 mm	36	72	32	52	0.45	

* Kvs-value in m³/h at a pressure drop of 1 bar; Flow chart, see product catalogue. CPF = compression fitting.